

Aurora Doors

**Practicality
in design.**

www.criterionindustries.com.au





Aurora Doors

44MM DOOR SUITE

The Aurora Aluminium collection offers a wide range of door that suit a variety of applications throughout commercial and residential settings. Constructed with strong and durable components, Aurora doors are low maintenance and deliver consistent high performance in heavy traffic settings.

Available to suit a wide variety of applications including hinged, sliding, pivot and bi-fold configurations, these sections are stocked to ensure fast delivery. Aurora doors are manufactured with rubber glazing which allows for pre-glazing prior to installation.

Available in different powder coat and anodised finishes, our doors suit a variety of acoustic and weather seals. Each component can be ordered individually, including glazing beads, glazing blocks, pivot seals, pull handles, wiper stiles, top rails, mid rails, rebate adaptors and bottom rails.

Designed and customised to suit a range of project requirements, Aurora aluminium doors are purpose-engineered for the pressures of continual use within commercial settings. In addition to robust performance, the Aurora Aluminium collection delivers a contemporary finish to interior spaces.

WHY CHOOSE AURORA ALUMINIUM DOORS?

- + **Narrow (68mm) and Wide (116mm) Door Stiles**
- + **44mm door thickness**
- + **In-house manufacturing including rubber glazing and fitting of door furniture**
- + **Suits locks, catches, weather and acoustic seals**
- + **Suits up to 10.8mm glass**
- + **Suitable for both hinged & the following sliding systems:**
 - Platinum 90 Integrated Sliding System
 - Arctic Sliding Track
 - Atlantic Sliding Track
 - Amazon Sliding Track
 - Niagara Sliding Track
- + **Acoustic Ratings:**
 - Aurora Narrow Stile Door – RW35
 - Aurora Wide Stile Door – RW32

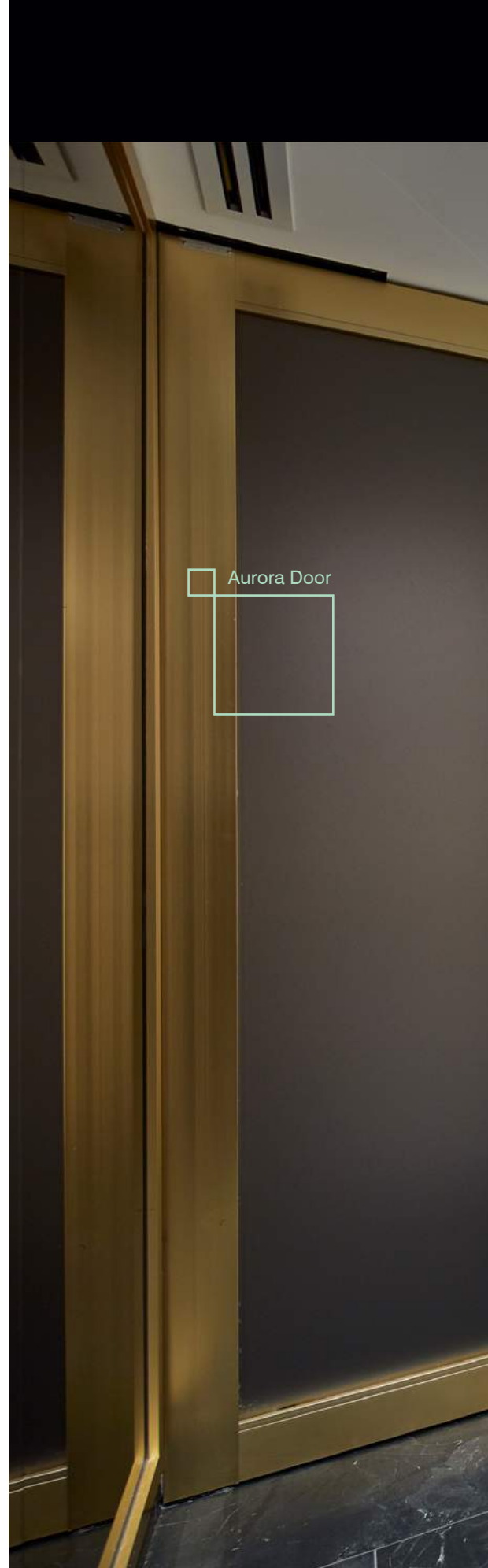







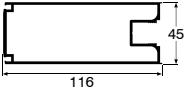
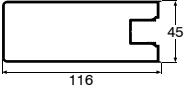
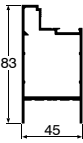
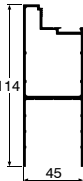

AURORA DOOR - NEW AMENITIES BATHROOM -
LEVEL 12 101 COLLINS ST, MELBOURNE
©AARON POCOCK PHOTOGRAPHY

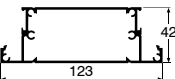

SECTION IMAGE	DESCRIPTION	LENGTH	FINISH	CODE
	CI-5021 Narrow 66mm Lock Stile	2800mm	Clear Anodise	502128.1
		2800mm	Satin Black	502128.B
		2800mm	Satin White	502128.W
		5500mm	Clear Anodise	502155.1
		6500mm	Clear Anodise	502165.1
	CI-5022 Narrow 66mm Hinge Stile	2800mm	Clear Anodise	502228.1
		2800mm	Satin Black	502228.B
		2800mm	Satin White	502228.W
		5500mm	Clear Anodise	502255.1
		6500mm	Clear Anodise	502265.1
	CI-5026 Narrow 66mm Wiper Stile	2800mm	Clear Anodise	502628.1
		2800mm	Satin Black	502628.B
		2800mm	Satin White	502628.W
		5500mm	Clear Anodise	502655.1
		6500mm	Clear Anodise	502665.1
	CI-5027 Narrow 66mm Pivot Stile	2800mm	Clear Anodise	502728.1
		5500mm	Clear Anodise	502755.1
		6500mm	Clear Anodise	502765.1
		2800mm	Clear Anodise	502828.1
	CI-5028 Narrow 66mm Plain Stile	2800mm	Satin Black	502828.B
		2800mm	Satin White	502828.W
		5500mm	Clear Anodise	502855.1
		6500mm	Clear Anodise	502865.1
		2800mm	Clear Anodise	503128.1
	CI-5031 Wide 114mm Lock Stile	2800mm	Satin Black	503128.B
		2800mm	Satin White	503128.W
		5500mm	Clear Anodise	503155.1
		5500mm	Satin Black	503155.B
		6500mm	Clear Anodise	503165.1
		2800mm	Clear Anodise	503228.1
	CI-5032 Wide 114mm Hinge Stile	2800mm	Satin Black	503228.B
		2800mm	Satin White	503228.W
		5500mm	Clear Anodise	503255.1
		5500mm	Satin Black	503255.B
		6500mm	Clear Anodise	503265.1
		2800mm	Clear Anodise	503628.1
	CI-5036 Wide 114mm Wiper Stile	2800mm	Satin Black	503628.B
		2800mm	Satin White	503628.W
		5500mm	Clear Anodise	503655.1
		6500mm	Clear Anodise	503665.1
		2800mm	Clear Anodise	503628.1

SECTION IMAGE	DESCRIPTION	LENGTH	FINISH	CODE
	CI-5037 Wide 114mm Pivot Stile	2800mm	Clear Anodise	503728.1
		5500mm	Clear Anodise	503755.1
		6500mm	Clear Anodise	503765.1
	CI-5038 Wide 114mm Plain Stile	2800mm	Clear Anodise	503828.1
		2800mm	Satin Black	503828.B
		2800mm	Satin White	503828.W
		5500mm	Clear Anodise	503855.1
	CI-5023 Narrow 83mm Rail	6500mm	Clear Anodise	503865.1
		2800mm	Satin White	502328.W
		2800mm	Satin Black	502328.B
		5500mm	Satin Black	502355.B
	CI-5024 Wide 114mm Rail	6500mm	Clear Anodise	502365.1
		2800mm	Satin White	502428.W
		2800mm	Satin Black	502428.B
		5500mm	Satin Black	502455.B
	CI-5029 Mid Rail 45mm	6500mm	Clear Anodise	502465.1
	CI-5039 Mid Rail 123mm	6500mm	Clear Anodise	502965.1
	CI-5025 Glazing Bead	3250mm	Satin White	502532.W
		3250mm	Satin Black	502532.B
		5500mm	Satin Black	502555.B
		6500mm	Clear Anodise	502565.1
	CI-5091 Interlock Adaptor	6500mm	Clear Anodise	509165.1
	CI-5092 Rebate Adaptor	6500mm	Clear Anodise	509265.1
	CI-5093 Flush Pull Handle	2750mm	Clear Anodise	509328.1



AURORA HINGE DOOR MANUFACTURING OPTIONS

STANDARD MEASURING AND MANUFACTURING DETAILS - HINGE

DOOR WIDTH	Daylight Width - 9mm
DOUBLE DOOR WIDTH	Daylight Width - 13mm (4mm each side for hinges and 5mm gap between meeting stiles)
DOOR HEIGHT	Daylight Height - 13mm off Finished Floor Level (3mm from the top and 12mm from base) - X (allowances for Floor Finishes)

METHOD OF MEASURING DOOR OPENINGS

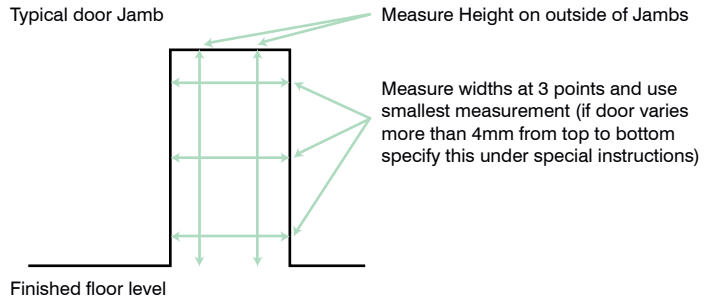

HANDING LEGEND

LEFT HANDED DOORS

RIGHT HANDED DOORS

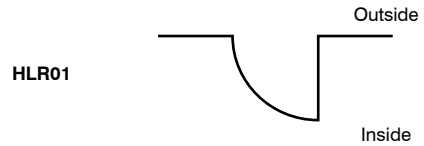
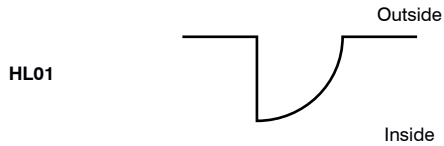

ACTIVE LEAF

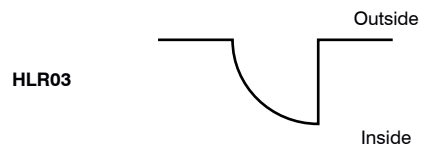
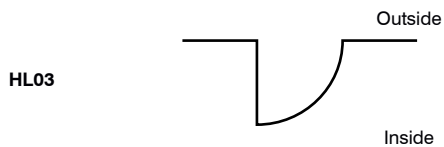
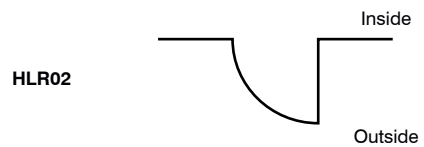
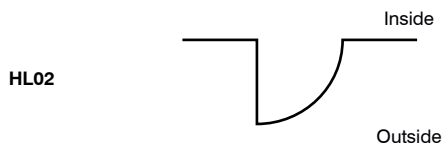

INACTIVE LEAF

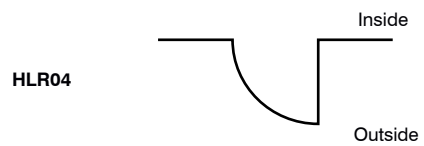
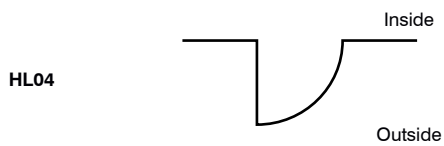

AURORA SLIDING DOOR MANUFACTURING OPTIONS

STANDARD MEASURING AND MANUFACTURING DETAILS - SLIDING

METHOD OF MEASURING

Refer to Sliding System section to confirm measurements

HANDING LEGEND

PLAIN / PLAIN

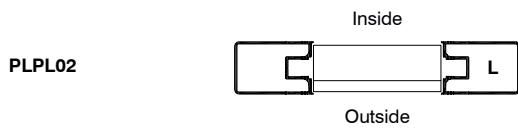
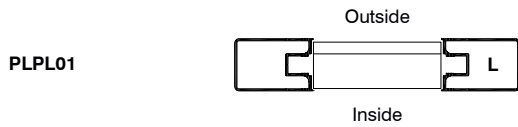

WIPER / WIPER

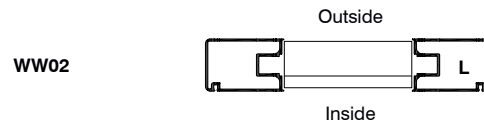
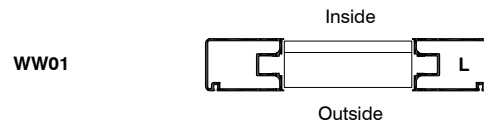

WIPER / PIVOT

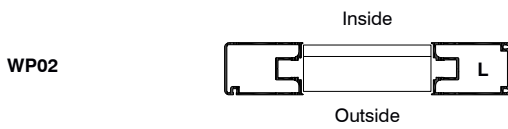
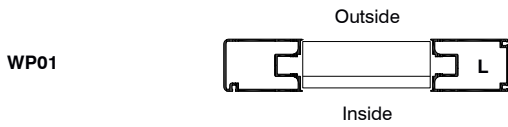

PIVOT / WIPER

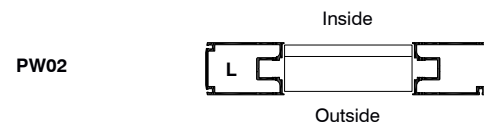
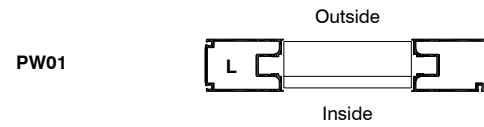

WIPER / PLAIN

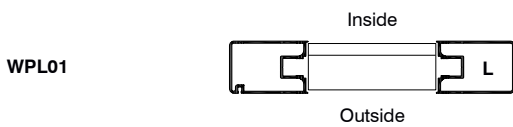
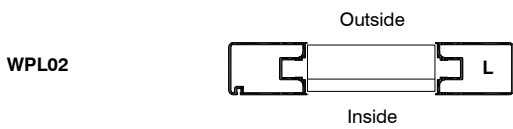



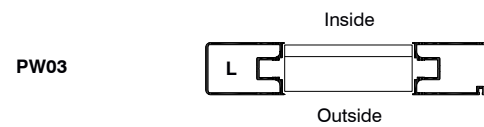
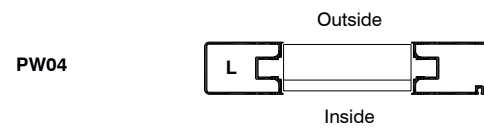







PLAIN / WIPER











L = Leading stile



DOOR FURNITURE

IMAGE	DESCRIPTION	FINISH	CODE	COMPATIBLE WITH	
				AURORA WIDE STYLE DOORS	AURORA NARROW STYLE DOORS
STANDARD BACKSET					
Mortice Locks					
	60mm Backset Primary Mortice Lock	SSS	806100	▲	
		Black	806100.B	▲	
	60mm Backset Primary Sliding Mortice Lock	SSS	806300	▲	
	89mm Backset Primary Mortice Lock	SSS	800100		
	89mm Backset Sliding Door Primary Mortice Lock	SSS	800101		
	89mm Backset Deadbolt Mortice Lock	SSS	800102		
Standard 60mm Backset Lock Kits					
	60mm Backset Lock Kit with Levers (Cylinder and Turnsnib)	SSS	800120	▲	
	60mm Backset Lock Kit with Levers (Cylinder and Plain)	SSS	800121	▲	
	60mm Backset Lock Kit with Levers (Plain and Plain)	SSS	800123	▲	
Cylinders, Adaptors & Cams					
	Oval Cylinder '1' Cam KD (Retracts Bolt) Suits 806100 & 800400	SSS	809080	▲	
	Oval Cylinder '1' Cam KA (Retracts Bolt) Suit 806100 & 800400	SSS	809081	▲	
	Oval Cylinder '2' Cam KD (Locks Handles) Suits 806100 & 800400	SSS	809070	▲	
	Oval Cylinder '2' Cam KA (Locks Handles) Suits 806100 & 800400	SSS	809071	▲	
	Oval Cylinder '3' Cam KD (Retracts Bolt) Suits 806300	SSS	809090	▲	
	Oval Cylinder '3' Cam KA (Retracts Bolt) Suits 806200 & 806300	SSS	809091	▲	
	Oval Cylinder '5' Cam KD (Turnsnib) Suits 806100 & 800400	SSS	809060	▲	
	Oval Cylinder '5' Cam KA (Turnsnib) Suits 806100 & 800400	SSS	809061	▲	
	Turnsnib Adaptor TA6 (Locks Handles) Suits 806100 & 800400	SSS	806501	▲	
	Turnsnib Adaptor TA7 (Retracts Bolt) Suits 806200 & 806300	SSS	806503	▲	
Levers to suit 60mm Backset Mortice Locks					
	External Plate with Lever & Cylinder Hole	SSS	804150	▲	
	Internal Plate with Lever & Turnsnib Assembly	SSS	804350	▲	
	External Plain Plate with Lever	SSS	804550	▲	
	Internal Plain Plate with Lever	SSS	804650	▲	
		SSS	802150	▲	
	Round Rose - Full Set with 10 Lever	Black	802150.B	▲	
	Round Rose - Full Set with 34 Lever	Black	802160.B	▲	
		SSS	802007	▲	
	Turn Snib - Round Escutcheon	Black	802007.B	▲	
		SSS	802008	▲	
	Oval Cylinder Hole - Round Escutcheon	Black	802008.B	▲	

COMPATIBLE WITH









IMAGE	DESCRIPTION	FINISH	CODE	AURORA WIDE STILE DOORS	AURORA NARROW STILE DOORS
NARROW BACKSET					
Narrow Backset Mortice Locks					
	23mm Backset Primary Latch	SSS	800400	▲	▲
		Black	800400.B	▲	▲
	30mm Backset Primary Mortice Locks	SSS	800110	▲	▲
	Flip-Lock Pack (Incl. Cyl. & T-snib) 22mm Lock Tongue - Single Door	SSS	801622	▲	▲
	Flip-Lock Pack (Incl. Cyl. & T-snib) 37mm Lock Tongue - Double Door	SSS	801637	▲	▲
	Flip-Lock Sliding Door Fab Pack (Includes Cyl. & T-snib)	SSS	801629	▲	▲
	Flip Lock Hook Throw Receiver Box	SSS	801004	▲	▲
Fliplock Cylinders					
	Oval Cylinder R Cam KD (Rabbit Ear) - To Suit Flip Lock	SSS	809050	▲	▲
	Oval Cylinder R Cam KA (Rabbit Ear) - To Suit Flip Lock	SSS	809051	▲	▲
Narrow 23mm Backset Lock Kits					
	23mm Backset Lock Kit with Levers (Cylinder & Turnsnib)	SSS	800420	▲	▲
	23mm Backset Lock Kit with Levers (Cylinder & Plain)	SSS	800421	▲	▲
	23mm Backset Lock Kit with Levers (Plain & Plain)	SSS	800423	▲	▲
Levers to suit 23mm Backset Mortice Locks					
	External Plate with Lever and Cylinder Hole	SSS	803150	▲	▲
	Internal Plate with Lever and Turnsnib Assembly	SSS	803350	▲	▲
	External Plain Plate with Lever	SSS	803550	▲	▲
	Internal Plain Plate with Lever	SSS	803650	▲	▲
LATCHES & LEVERS					
Latches					
	Tubular Latch - 60mm Backset includes Flat Striker	SSS	801000	▲	
		Black	801000.B	▲	
	Roller Bolt	SSS	801008	▲	
Indicator Set					
	Standard Indicator Set	—	800010	▲	▲
Lever Sets					
	Entrance Leverset*	SSS	803004	▲	
	Passage Leverset*	SSS	803005	▲	
	Privacy Set (Emergency Slot Release & Turnsnib Inside)	SSS	803006	▲	
	Storeroom Set (Key Retracts Latch & Inside Escape)	SSS	803007	▲	
	Classroom Set (Key Unlocks Outside Lever & Inside Escape)	SSS	803008	▲	

* DDA compliant

















DOOR FURNITURE

COMPATIBLE WITH

IMAGE	DESCRIPTION	FINISH	CODE	AURORA WIDE STILE DOORS	AURORA NARROW STILE DOORS
NARROW BACKSET					
Narrow Backset Mortice Locks					
	23mm Backset Primary Latch	SSS	800400	▲	▲
		Black	800400.B	▲	▲
	30mm Backset Primary Mortice Locks	SSS	800110	▲	▲
	Flip-Lock Pack (Incl. Cyl. & T-snib) 22mm Lock Tongue - Single Door	SSS	801622	▲	▲
	Flip-Lock Pack (Incl. Cyl. & T-snib) 37mm Lock Tongue - Double Door	SSS	801637	▲	▲
	Flip-Lock Sliding Door Fab Pack (Includes Cyl. & T-snib)	SSS	801629	▲	▲
	Flip Lock Hook Throw Receiver Box	SSS	801004	▲	▲
Fliplock Cylinders					
	Oval Cylinder R Cam KD (Rabbit Ear) - To Suit Flip Lock	SSS	809050	▲	▲
	Oval Cylinder R Cam KA (Rabbit Ear) - To Suit Flip Lock	SSS	809051	▲	▲
Narrow 23mm Backset Lock Kits					
	23mm Backset Lock Kit with Levers (Cylinder & Turnsnob)	SSS	800420	▲	▲
	23mm Backset Lock Kit with Levers (Cylinder & Plain)	SSS	800421	▲	▲
	23mm Backset Lock Kit with Levers (Plain & Plain)	SSS	800423	▲	▲
Levers to suit 23mm Backset Mortice Locks					
	External Plate with Lever and Cylinder Hole	SSS	803150	▲	▲
	Internal Plate with Lever and Turnsnob Assembly	SSS	803350	▲	▲
	External Plain Plate with Lever	SSS	803550	▲	▲
	Internal Plain Plate with Lever	SSS	803650	▲	▲
LATCHES & LEVERS					
Latches					
	Tubular Latch - 60mm Backset includes Flat Striker	SSS	801000	▲	
		Black	801000.B	▲	
	Roller Bolt	SSS	801008	▲	
Indicator Set					
	Standard Indicator Set	—	800010	▲	▲
Lever Sets					
	Entrance Leverset*	SSS	803004	▲	
	Passage Leverset*	SSS	803005	▲	
	Privacy Set (Emergency Slot Release & Turnsnob Inside)	SSS	803006	▲	
	Storeroom Set (Key Retracts Latch & Inside Escape)	SSS	803007	▲	
	Classroom Set (Key Unlocks Outside Lever & Inside Escape)	SSS	803008	▲	

* DDA compliant

COMPATIBLE WITH

IMAGE	DESCRIPTION	FINISH	CODE	AURORA WIDE STYLE DOORS	AURORA NARROW STYLE DOORS
LOCKWOOD					
Standard 60mm Backset Mortice Locks					
	Mortice Primary Lock	SSS	801572	▲	
	Sliding Door Mortice Primary Lock	SSS	801573	▲	
Cylinders & Cams					
	Oval Cylinder 'W' Cam KD (Turnsnib) Suits 801572 & 801582	SSS	809010	▲	
	Oval Cylinder 'W' Cam KA (Turnsnib) Suits 801572 & 801582	SSS	809011	▲	
	Oval Cylinder 'Z' Cam KD (Locks Handles) Suits 801572 & 801582	SSS	809020	▲	
	Oval Cylinder 'Z' Cam KA (Locks Handles) Suits 801572 & 801582	SSS	809021	▲	
	Oval Cylinder 'X' Cam KD (Retracts Bolt) Suits 801572 & 801582	SSS	809030	▲	
	Oval Cylinder 'X' Cam KA (Retracts Bolt) Suits 801572 & 801582	SSS	809031	▲	
	Oval Cylinder 'Y' Cam KD (Retracts Bolt) Suits 801573	SSS	809040	▲	
	Oval Cylinder 'Y' Cam KA (Retracts Bolt) Suits 801573	SSS	809041	▲	
	Turnsnib Adaptor Lock Handles	SSS	801580		
	Turnsnib Adaptor Retract Latching Bolt	SSS	801583		
	Turnsnib Adaptor Retract Deadbolt	SSS	801585		
Levers to suit 60mm Backset Mortice Locks					
	External Plate with Lever & Cylinder Hole	SSS	801801	▲	
	External Plain Plate with Lever	SSS	801805	▲	
	Internal Plate with Lever & Turnsnib Assembly	SSS	801904	▲	
	Internal Plate with Lever	SSS	801905	▲	
	Round Rose Lever Set	SSS	801360	▲	
	Round Escutcheon Oval Cylinder Hole	SSS	801366	▲	
	Round Escutcheon/Indexing Turnsnib Assembly	SSS	801367	▲	



DOOR FURNITURE

























IMAGE	DESCRIPTION	FINISH	UNIT	CODE	COMPATIBLE WITH	
					AURORA WIDE STILE DOORS	AURORA NARROW STILE DOORS
LOCKWOOD CONTINUED						
Narrow 23mm Backset Mortice Locks						
	Narrow Backset Mortice Primary Latch	SSS	—	801582	▲	▲
Levers to suit 23mm Backset Mortice Locks						
	External Plate with Lever & Cylinder Hole	SSS	—	801481	▲	▲
	External Plain Plate with Lever	SSS	—	801485	▲	▲
	Internal Plain Plate with Lever & Turnsnib Assembly	SSS	—	801494	▲	▲
	Internal Plain Plate with Lever	SSS	—	801495	▲	▲
Lever Sets						
	Entrance Set	SSS	—	801930	▲	
	Passage Set	SSS	—	801931	▲	
RUBBERS & SEALS						
Rubbers						
	6.38mm Glazing Channel Rubber	Black	Lineal Metre	841206B	▲	▲
		Grey	Lineal Metre	841206G	▲	▲
	10.38mm Glazing Channel Rubber	Black	Lineal Metre	841207.B	▲	▲
		Grey	Lineal Metre	841207.G	▲	▲
	6.38mm Glazing Rubber	Black	Lineal Metre	841025.B	▲	▲
	8.38mm Glazing Rubber	Black	Lineal Metre	841011.B	▲	▲
	10.38mm Glazing Rubber	Black	Lineal Metre	841201.B	▲	▲

IMAGE	DESCRIPTION	LENGTH	FINISH	CODE	AURORA WIDE STILE DOORS	AURORA NARROW STILE DOORS
RUBBERS & SEALS CONTINUED						
Door Seals						
	Whisperwing Rubber Door Seal	Lineal Metre	Black	841469.B	▲	▲
		100m Roll	Black	841469.BBR	▲	▲
		Lineal Metre	Grey	841469.G	▲	▲
		100m Roll	Grey	841469.GBR	▲	▲
	Whisper-Lon Seal - Suits 38mm Sliding Doors	Lineal Metre	Black	843705.B	▲	▲
		100m Roll	Black	843705.BBR1	▲	▲
		500m Roll	Black	843705.BBR	▲	▲
	6.9mm Door Seal	Lineal Metre	Black	843694.B	▲	▲
		100m Roll	Black	843694.BBR	▲	▲
		Lineal Metre	Grey	843694.G	▲	▲
		100m Roll	Grey	843694.GBR	▲	▲
	6.9mm Door Seal Self Adhesive	Lineal Metre	Black	843694.BSA	▲	▲
		100m Roll	Black	843694.BSABR	▲	▲
		Lineal Metre	Grey	843694.GSA	▲	▲
		100m Roll	Grey	843694.GSABR	▲	▲
	6.9mm Door Seal with 9mm Pile	Lineal Metre	Black	843699.B	▲	▲
		300m Roll	Black	843699.BBR	▲	▲
		Lineal Metre	Grey	843699.G	▲	▲
		300m Roll	Grey	843699.GBR	▲	▲
	6.9mm Door Stop Rubber (Bulb Seal)	Lineal Metre	Black	841369.B	▲	▲
		100m Roll	Black	841369.BBR	▲	▲
	10mm Hole Plug	—	Black	810130	▲	▲
	13mm Pivot Seal	Lineal Metre	Black	843011.B	▲	▲
		100m Roll	Black	843011.BB1	▲	▲
		600m Roll	Black	843011.BBR	▲	▲
		Lineal Metre	Grey	843011.G	▲	▲
	16mm Pivot Seal	100m Roll	Grey	843011.GB1	▲	▲
		600m Roll	Grey	843011.GBR	▲	▲
		Lineal Metre	Black	843016.B	▲	▲
		500m Roll	Black	843016.BBR	▲	▲
16mm Pivot Seal	Lineal Metre	Grey	843016.G	▲	▲	
	500m Roll	Grey	843016.GBR	▲	▲	









DOOR FURNITURE

COMPATIBLE WITH

IMAGE	DESCRIPTION	LENGTH	FINISH	UNIT	CODE	AURORA WIDE STILE DOORS	AURORA NARROW STILE DOORS
RUBBERS & SEALS CONTINUED							
Door Seals Continued							
	Perimeter Door Seal - Short Single	2100 x 1000	SSS	Each	812614	▲	▲
	Perimeter Door Seal - Long Single	2700 x 1000	SSS	Each	812616	▲	▲
	Perimeter Door Seal - Short Double	2100 x 2000	SSS	Each	812617	▲	▲
	Perimeter Door Seal - Long Double	2700 x 2000	SSS	Each	812618	▲	▲
	Heavy Duty Base Door Seal	Base 920	SSS	Each	812675	▲	▲
		Base 1070	SSS	Each	812620	▲	▲
	Heavy Duty Base Door Seal (Facefix/Semi Rebate)	Base 920	SSS	Each	812623	▲	▲
		Base 1070	SSS	Each	812624	▲	▲
	Base Door Seal	Base 820	SSS	Each	812684	▲	▲
		Base 920	SSS	Each	812685	▲	▲
		Base 1070	SSS	Each	812686	▲	▲
		Base 1220	SSS	Each	812687	▲	▲
		Base 610	SSS	Each	812688	▲	▲
DOOR CLOSERS							
Compact Door Closers - Series 4							
	Compact Door Closer with Parallel Arm Bracket Size 2-4	—	SSS	Each	812112	▲	▲
	Compact Door Closer - Hold Open Arm (to suit D4 Series Door Closer)	—	SSS	Each	812113	▲	▲
	Compact Door Closer - Drop Plate	—	SSS	Each	812114	▲	▲
	Compact Door Closer - Mount Plate	—	SSS	Each	812115	▲	▲
Medium Door Closers - Series 5							
	Medium Door Closer with Slide Arm & Hold Open Function - Size 1-3	—	SSS	Each	812317	▲	▲
	Medium Door Close Adjustable By Position Size 2-4	—	SSS	Each	812316	▲	▲

COMPATIBLE WITH

IMAGE	DESCRIPTION	FINISH	UNIT	CODE	AURORA WIDE STILE DOORS	AURORA NARROW STILE DOORS
DOOR CLOSERS CONTINUED						
Large Door Closers - Series 6						
	Large Door Closer Adjustable By Position with Parallel Arm Bracket Size 2-5	SSS	Each	812601	▲	▲
	Large Door Closer Adjustable By Position with Parallel Arm Bracket (Slide Arm and Hold Open Function)	SSS	Each	812606	▲	▲
	Large Door Closer Adjustable By Position with Parallel Arm Bracket Size 2-5	Black	Each	812601.B	▲	▲
Extra Large Door Closers - Series 7						
	Extra Large Door Closer Adjustable By Position with Parallel Arm Bracket Size 2-6	SSS	Each	812701	▲	▲
	Extra Large Door Closer Adjustable By Position with Parallel Arm Bracket (Slide Arm and Hold Open Function)	SSS	Each	812703	▲	▲
Door Closer Accessories						
	Hold Open Arm Only (Suits Medium - Extra Large Door Closer)	SSS	Each	812605	▲	▲
	Mount Plate Only (Suits Medium - Extra Large Door Closer)	SSS	Each	812609	▲	▲
	Slide Rail w/Hold Open Function (Suits Medium - Extra Large Closers)	SSS	Each	812604	▲	▲
		Black	Each	812604.B	▲	▲
Transom Closers						
	Overhead Transom Closer Kit – Includes Closer, Top Arm & Base Arm	SSS	Each	812412	▲	▲
	Transom Closer Hold Open 90 Degrees	SSS	Each	812413	▲	▲
	Bottom Centre Pivot Set	SSS	Each	812514	▲	▲
	Floor Bearing Pivot	SSS	Each	812519	▲	▲
Floor Springs						
	Heavy Duty Floor Spring Kit	SSS	Each	812510	▲	▲
	Top Centre Pivot Set	SSS	Each	852519	▲	▲
	Bottom Strap	SSS	Each	812515	▲	▲



DOOR FURNITURE

COMPATIBLE WITH

IMAGE	DESCRIPTION	SIZE	FINISH	UNIT	CODE	AURORA WIDE STILE DOORS	AURORA NARROW STILE DOORS
HANDLES							
Entrance Handles							
	Chromis 61 25mm Square Section Back to Back	300 C x 325 L	SSS	Pair	815001	▲	▲
		600 C x 625 L	SSS	Pair	815002	▲	▲
		600 C x 625 L	Black	Pair	815002.B	▲	▲
	Chromis 62 32mm Round Back to Back	32 D x 300 C	SSS	Pair	815010	▲	▲
		32 D x 600 C	SSS	Pair	815011	▲	▲
	Chromis 63 32mm Round Offset Back to Back	32 D x 300 C	SSS	Pair	815020	▲	▲
	Chromis 64 25mm Square Offset Section Back to Back	300 C x 325 L	SSS	Pair	815030	▲	▲
		600 C x 625 L	SSS	Pair	815031	▲	▲
		600 C x 625 L	Black	Pair	815031.B	▲	▲
	Chromis 66 32mm Round Back to Back H Pull	32 D x 450 C x 600 L	SSS	Pair	815050	▲	▲
		32 D x 600 C x 1000 L	SSS	Pair	815051	▲	▲
	Chromis 69 Premium Push/Pull Set	300 x 100	SSS	Pair	815080	▲	
	Chromis 69 Pull Plate Plain - Concealed Fix	300 x 65	SSS	Pair	815083	▲	
	Chromis 69 Pull Plate Plain - Visible Fix	300 x 65	SSS	Pair	815230.5	▲	
	Chromis 69 Push Plate - Visible Fix	300 x 65	SSS	Pair	815230.6	▲	
	Chromis 69 Push/Pull Plate Set - Visible Fix	300 x 65	SSS	Pair	815230.7	▲	
Flush Pull / Finger Pull							
	Flush Pull - Pair	146mm H x 40mm W	SSS	Each	816146	▲	▲
	Edge Finger Pull	70H x 19 x 17D	SSS	Each	817154	▲	▲









COMPATIBLE WITH

IMAGE	DESCRIPTION	FINISH	UNIT	CODE	AURORA WIDE STILE DOORS	AURORA NARROW STILE DOORS
HINGES						
	Stainless Steel Interfold Hinges	SSS	Each	811020	▲	▲
		Black	Each	811020.B	▲	▲
		SSS	Box of 20	811020BR	▲	▲
	Quick Fix Hinges	Clear Anodised	Each	811030.1	▲	▲
		Black	Each	811030.B	▲	▲
		White	Each	811030.W	▲	▲
		Clear Anodised	Box of 20	811030.1BR	▲	▲
	Aluminium Fast Fix Lift off Hinge LH	Clear Anodised	Each	811031.LH	▲	▲
	Aluminium Fast Fix Lift off Hinge RH	Clear Anodised	Each	811031.RH	▲	▲
	McCallum 104 Fast Fix Hinge	Mill Finish	Each	811032.0	▲	▲
		Clear Anodised	Each	811032.1	▲	▲
		Black	Each	811032.2B	▲	▲
	LH Lift Off Butt Hinge	SSS	Each	811050		
	RH Lift Off Butt Hinge	SSS	Each	811051		
	100 x 75mm Std Butt Hinge (loose pin)	SSS	Each	811052		
	100 x 75mm Butt Hinge (fixed pin)	SSS	Each	811053		
	100 x 100mm Butt Hinge (fixed pin)	SSS	Each	811054		
	Three leaf Hinge	SSS	Each	811033.1		
		Black	Each	811033.2		
	Gravity Hinge Set LH SC - Hold Open	—	Pair	800020.SC.HO	▲	▲
	Gravity Hinge Set RH SC - Hold Open	—	Pair	800021.SC.HO	▲	▲
	McCallum A115 Interfold Hinge	Clear Anodise	Each	811036.1	▲	▲
		Black	Each	811036.2	▲	▲
	McCallum A117 Interfold Hinge	Clear Anodise	Each	811038.1	▲	▲
		Black	Each	811038.2	▲	▲







DOOR FURNITURE

COMPATIBLE WITH

IMAGE	DESCRIPTION	SIZE	FINISH	UNIT	CODE	AURORA WIDE STILE DOORS	AURORA NARROW STILE DOORS
HINGES CONTINUED							
Hinge Screws							
	Critech Self Drilling Hinge Screw	10g x 16mm	—	Box of 1000	855016BR	▲	▲
		10g x 16mm	—	Bag of 100	855016BR1	▲	▲
		10g x 32mm	—	Bag of 100	855032BR1	▲	▲
	Critech Hinge Screw	10g x 32mm	—	Box of 500	855032BR5	▲	▲
		8g x 45mm	—	Box of 500	855045BR	▲	▲
	Metal Thread CSK Z/P Steel Door Frame Hinge Screw	M5 x 10mm	—	Box of 200	855010BR	▲	▲
DOOR STOPS							
	Pencil Door Stop - Wall Mounted	—	SSS	Each	813350	▲	▲
		—	SSS	Box of 10	813350BR	▲	▲
	Triangular Base Door Stop - Floor Mounted	—	SSS	Each	813250	▲	▲
		—	SSS	Box of 8	813250BR	▲	▲
	Cylinder Door Stop - Floor Mounted	—	SSS	Each	813280	▲	▲
		—	SSS	Box of 15	813280BR	▲	▲
	Half Moon Door Stop - Floor Mounted	—	SSS	Each	813290	▲	▲
		—	Black	Each	813290.B	▲	▲
		—	SSS	Box of 20	813290BR	▲	▲
	Square Door Stop	—	SSS	Each	813300	▲	▲
SPIGOTS							
	Midrail Bracket	—	—	Each	810014	▲	▲
	Spigot Pack	—	—	Each	810100	▲	▲

COMPATIBLE WITH

IMAGE	DESCRIPTION	SIZE	FINISH	UNIT	CODE	AURORA WIDE STILE DOORS	AURORA NARROW STILE DOORS
FLUSH & PANIC BOLTS							
	Flush Bolt Mechanism & Rod - Aluminium Doors	300mm	SSS	Each	814230	▲	▲
		600mm	SSS	Each	814260	▲	▲
	Flush Bolt Keeper (Screw Down)	—	—	Each	841303	▲	▲
	Top Hat Ferrule	—	SSS	Each	814302	▲	▲
	Visible Fix Panic Bolts	300mm	SSS	Each	818300	▲	▲
		600mm	SSS	Each	818600	▲	▲
	Concealed Fix Panic Bolt	300mm	SSS	Each	818301	▲	▲
		600mm	SSS	Each	818601	▲	▲

Practicality in design.

Looking to discover more?

Contact us to book your
free demonstration:

www.criterionindustries.com.au



VIC

23 Scanlon Drive
Epping, VIC, 3076
T: 03 9355 0700

sales@criterionindustries.com.au

NSW

95 Victoria Street
Smithfield, NSW, 2164
T: 02 9355 0700

sales.nsw@criterionindustries.com.au

WA

58 Tacoma Circuit
Canning Vale WA 6155
T: 08 9355 0700

sales.wa@criterionindustries.com.au

QLD

22 Holt Street
Eagle Farm QLD 4009
T: 07 3193 8990

sales.qld@criterionindustries.com.au