

Barwon Doors

Diversity
to adapt.

www.criterionindustries.com.au

 **Criterion**





Barwon Doors

38MM DOOR SUITE

Inspired by recent design trends for slim framed doors, the Barwon Aluminium Door Suite has been developed with an overall thickness of 38mm, delivering a sleek finish to both commercial and residential settings.

With a strong integral structure, the Barwon Door Suite allows for glass up to 12.8mm thick and complements Criterion's range of partition systems. This new range features a variety of frame options including a 42mm slimline stile with a lockable option.

Available for a wide variety of applications including hinged, sliding, pivot and bi-fold configurations, doors can be manufactured to your specification in either powdercoat or anodise finishes.

WHY CHOOSE BARWON?

- + **Slimline (42mm), Narrow (72mm) and Wide (112mm) Door Stiles**
- + **38mm door thickness**
- + **In-house manufacturing including rubber glazing and fitting of door furniture**
- + **Suits locks, catches, weather and acoustic seals**
- + **Suits up to 12.8mm glass**
- + **Suitable for both hinged & the following sliding systems:**
 - Platinum 90 Integrated Sliding System
 - Arctic Sliding Track
 - Atlantic Sliding Track
 - Amazon Sliding Track
 - Acacia Cavity Unit
 - Tanaro Cavity Unit





Barwon Door

BARWON DOOR - COMMERCIAL

FEATURES



Slimline Stile Door

The Slimline Door Stile is a sleek 42mm.

Narrow Stile Door

The 72mm Narrow Door Stile allows for a Narrow Backset Mortice Lock.

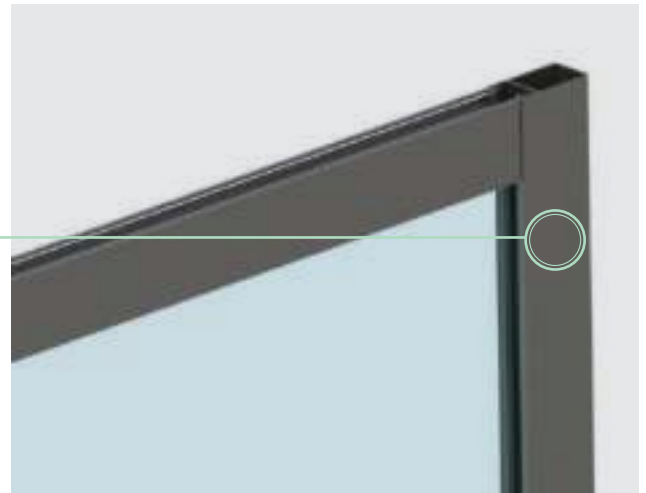

Wide Stile Door

The 112mm Wide Door Stile allows for a 60mm Backset Mortice Lock.

Lock Box

Incorporating a lock box into the Slimline Stile Door allows for a 89mm Backset Mortice Lock to be installed.

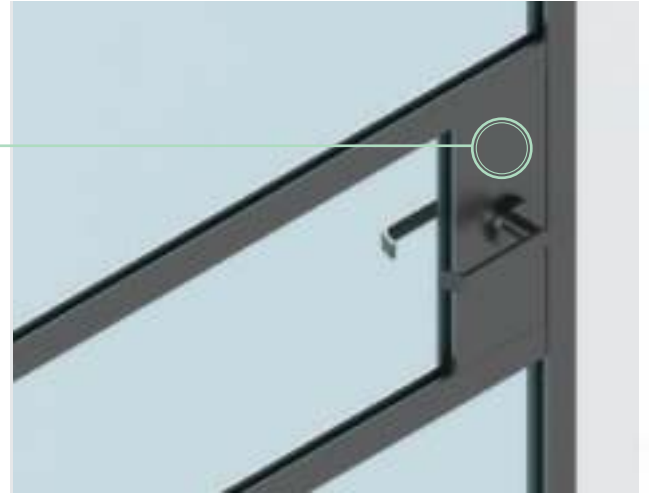

Designed to suit Arctic Sliding Track

The Narrow Rail is designed for quick and easy installation of the Arctic Low Clearance Sleeve.

Suits steel door frames

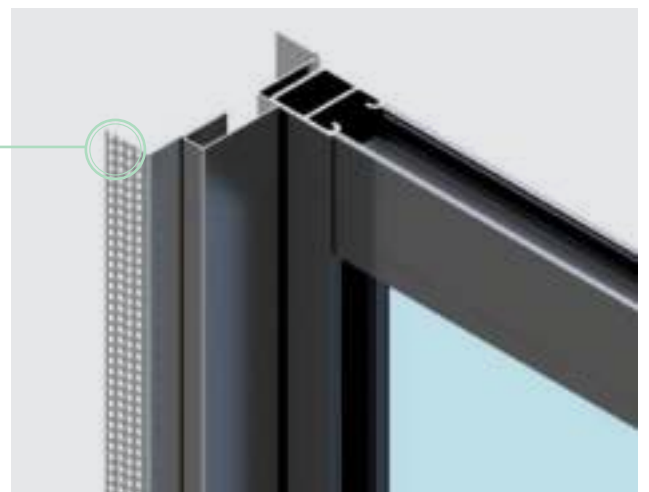

Mount into new or existing steel door frames including Split and Ezy Jamb.

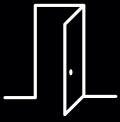

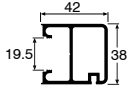
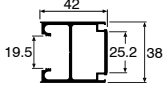
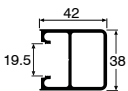

BARWON DOORS - 38MM SUITE

SECTION IMAGE	DESCRIPTION	LENGTH	FINISH	CODE
	CI-6023 Narrow Rail	6500mm	Clear Anodise	602365.1
	CI-6024 Wide Rail	6500mm	Clear Anodise	602465.1
	CI-6025 Snap Bead	6500mm	Clear Anodise	602565.1
	CI-6026 Narrow Wiper Stile	5500mm	Clear Anodise	602655.1
	CI-6027 Narrow Pivot Stile	5500mm	Clear Anodise	602755.1
	CI-6028 Narrow Plain Stile	5500mm	Clear Anodise	602855.1
	CI-6029 Narrow Midrail	6500mm	Clear Anodise	602965.1
	CI-6036 Wide Wiper Stile	5500mm	Clear Anodise	603655.1
	CI-6037 Wide Pivot Stile	5500mm	Clear Anodise	603755.1
	CI-6038 Wide Plain Stile	5500mm	Clear Anodise	603855.1
	CI-6039 Wide Rail Adaptor (Midrail)	6500mm	Clear Anodise	603965.1

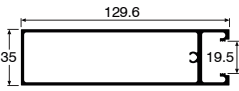
SECTION IMAGE	DESCRIPTION	LENGTH	FINISH	CODE
	CI-6046 Slimline Wiper Stile	5500mm	Clear Anodise	604655.1
	CI-6047 Slimline Pivot Stile	5500mm	Clear Anodise	604755.1
	CI-6048 Slimline Plain Stile	5500mm	Clear Anodise	604855.1
	CI-6092 Rebate Adaptor	6500mm	Clear Anodise	609265.1
	CI-810031 Slimline Door Lock Box	3000mm	Clear Anodise	810031.1



BARWON DOOR CONFIGURATIONS

WIDE STILE

NARROW STILE

SLIMLINE STILE

112mm

72mm

42mm



42mm

42mm

112mm

MAXIMUM DOOR SIZE GUIDE

GLASS TYPE	HEIGHT	WIDTH
6.38mm	2700mm	1050mm
10.38mm	3000mm	2000mm
12.38mm	3000mm	1900mm

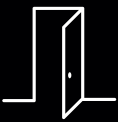

BARWON ELEVATIONS

PLATINUM 90 INTEGRATED BOTTOM ROLLER

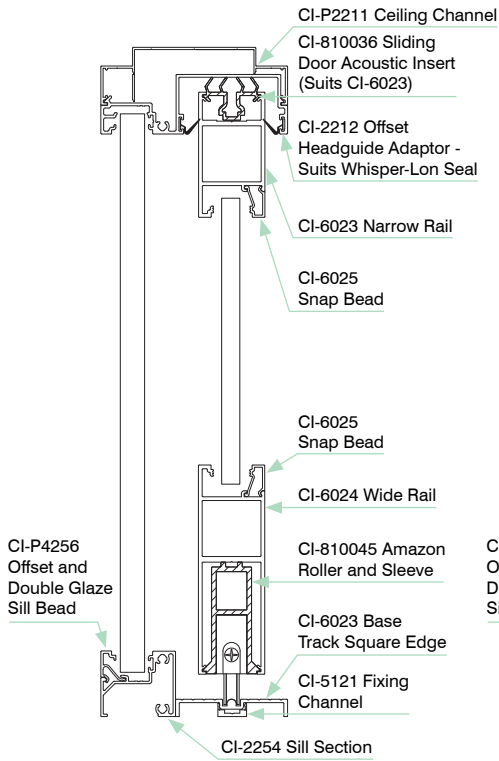

B.01

PLATINUM 90 INTEGRATED TOP ROLLER

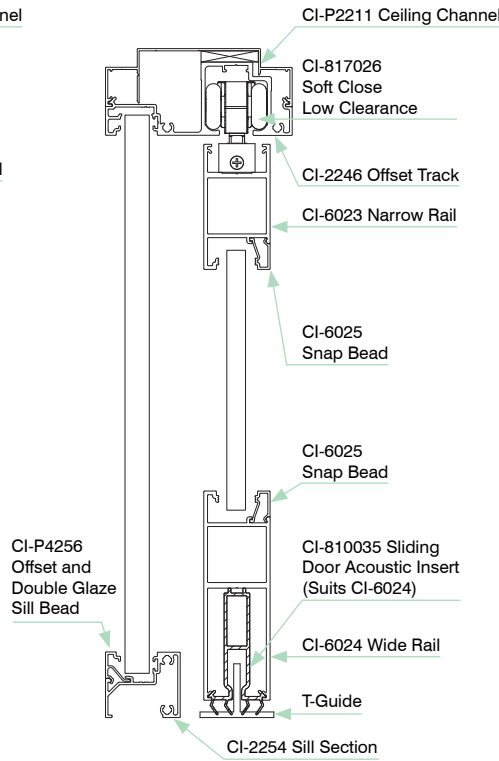

B.02

ARCTIC SLIDING SYSTEM

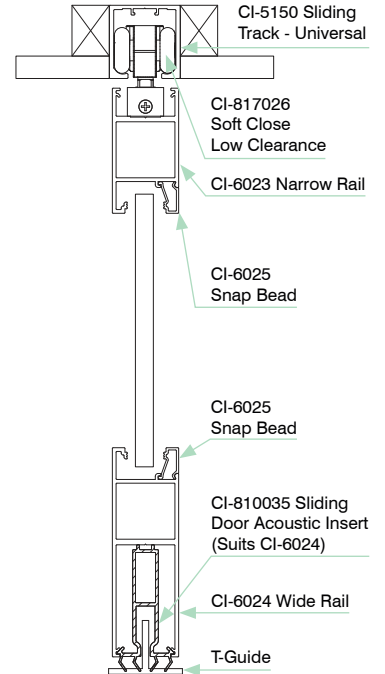

B.03

AMAZON SLIDING SYSTEM

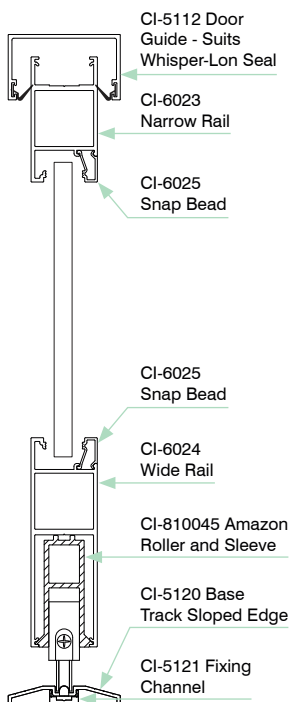

B.04

ATLANTIC SLIDING SYSTEM

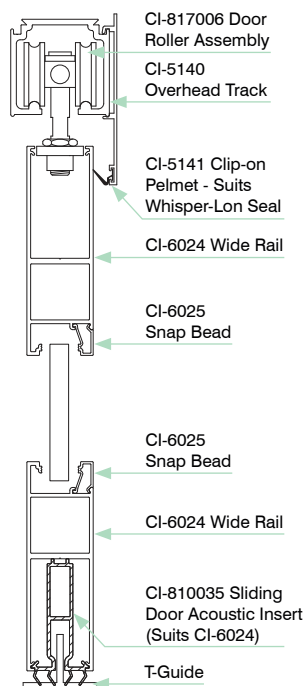

B.05

HINGE DOOR

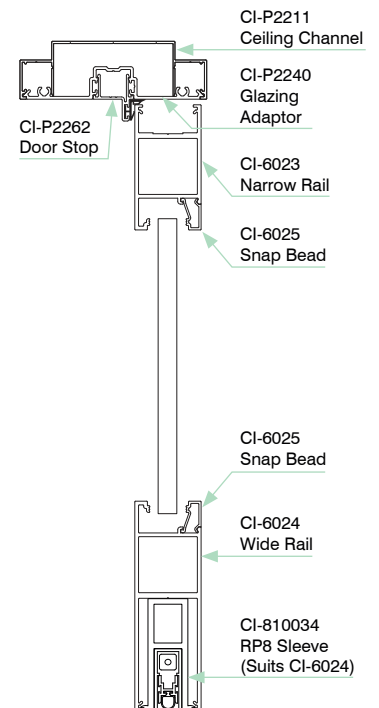

B.06



ATLANTIC, NIAGARA AND AMAZON SLIDING SYSTEM

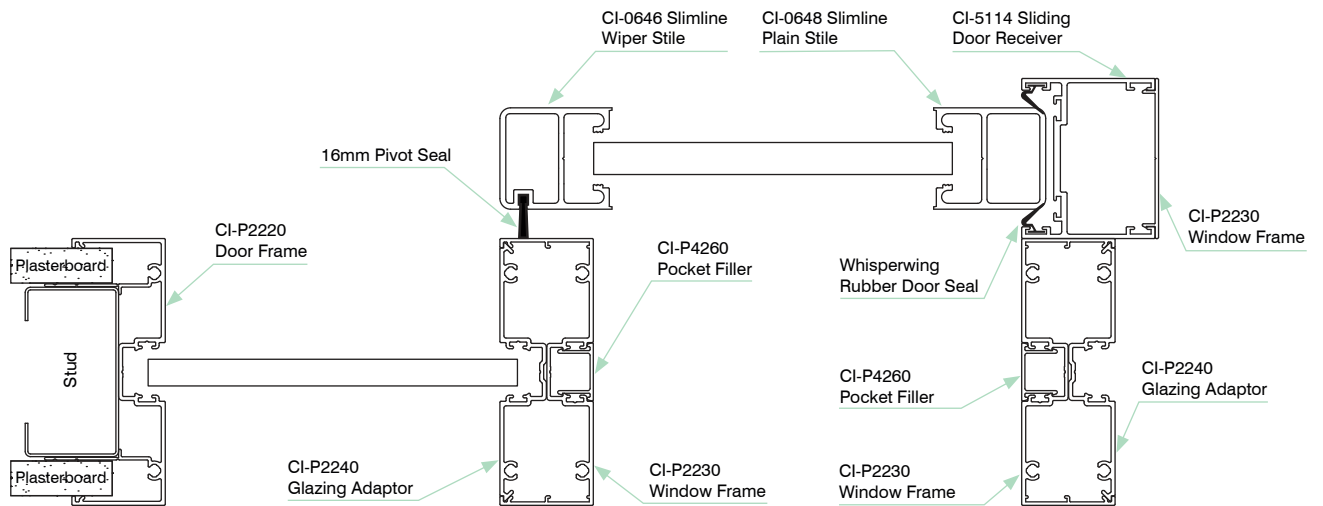

B.07

PLATINUM 90 INTEGRATED TOP AND BOTTOM ROLLER SYSTEM

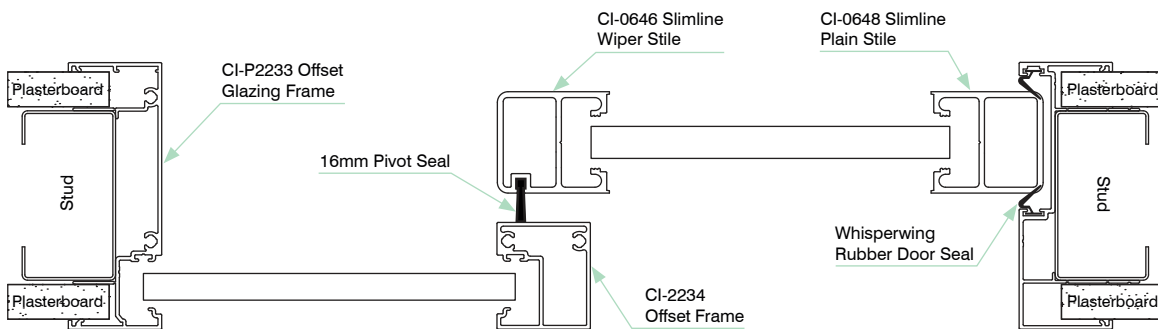

B.08

SLIMLINE STILE HINGE DOOR*



NARROW STILE HINGE DOOR

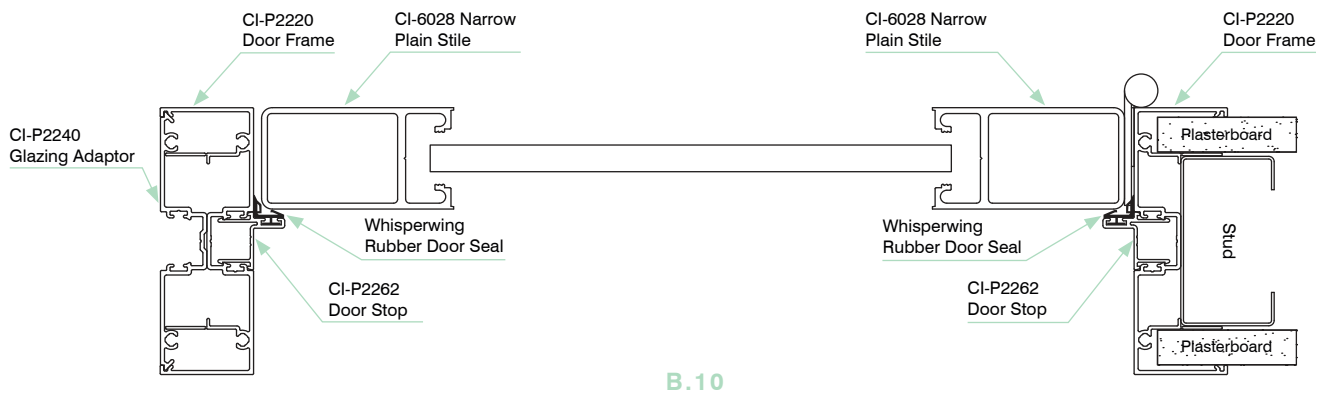

WIDE STILE HINGE DOOR

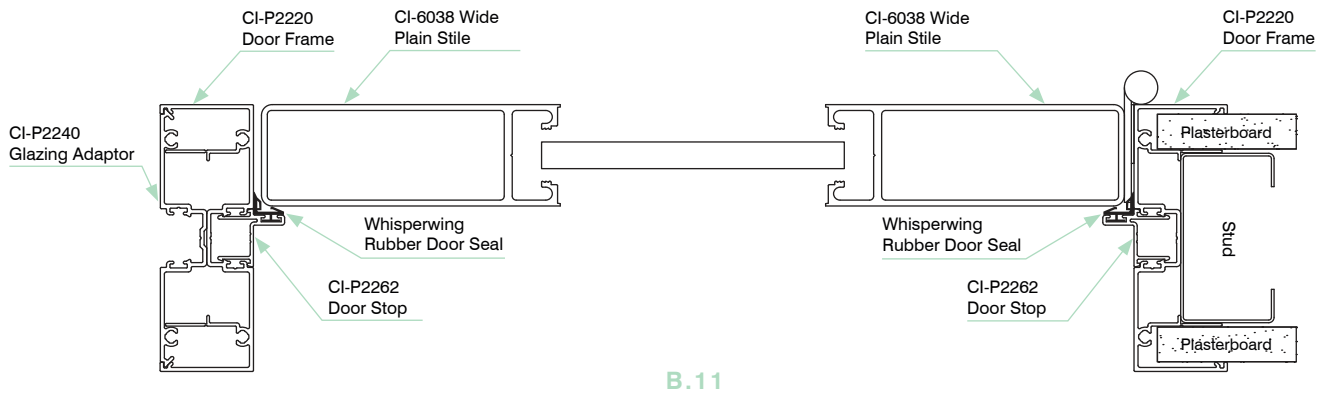









* Lock Box required for lockable doors.



IMAGE	DESCRIPTION	FINISH	CODE	COMPATIBLE WITH	
				BARWON WIDE STYLE DOORS	BARWON SLIMLINE WITH LOCK BOX
STANDARD BACKSET					
Mortice Locks					
	60mm Backset Primary Mortice Lock	SSS	806100	▲	
		Black	806100.B	▲	
	60mm Backset Primary Sliding Mortice Lock	SSS	806300	▲	
	89mm Backset Primary Mortice Lock	SSS	800100		▲
	89mm Backset Sliding Door Primary Mortice Lock	SSS	800101		▲
	89mm Backset Deadbolt Mortice Lock	SSS	800102		▲
Standard 60mm Backset Lock Kits					
	60mm Backset Lock Kit with Levers (Cylinder and Turnsnib)	SSS	800120	▲	
	60mm Backset Lock Kit with Levers (Cylinder and Plain)	SSS	800121	▲	
	60mm Backset Lock Kit with Levers (Plain and Plain)	SSS	800123	▲	
Cylinders, Adaptors & Cams					
	Oval Cylinder '1' Cam KD (Retracts Bolt) Suits 806100 & 800400	SSS	809080	▲	▲
	Oval Cylinder '1' Cam KA (Retracts Bolt) Suit 806100 & 800400	SSS	809081	▲	▲
	Oval Cylinder '2' Cam KD (Locks Handles) Suits 806100 & 800400	SSS	809070	▲	▲
	Oval Cylinder '2' Cam KA (Locks Handles) Suits 806100 & 800400	SSS	809071	▲	▲
	Oval Cylinder '3' Cam KD (Retracts Bolt) Suits 806300	SSS	809090	▲	▲
	Oval Cylinder '3' Cam KA (Retracts Bolt) Suits 806200 & 806300	SSS	809091	▲	▲
	Oval Cylinder '5' Cam KD (Turnsnib) Suits 806100 & 800400	SSS	809060	▲	▲
	Oval Cylinder '5' Cam KA (Turnsnib) Suits 806100 & 800400	SSS	809061	▲	▲
	Turnsnib Adaptor TA6 (Locks Handles) Suits 806100 & 800400	SSS	806501	▲	▲
	Turnsnib Adaptor TA7 (Retracts Bolt) Suits 806200 & 806300	SSS	806503	▲	▲
Levers to suit 60mm Backset Mortice Locks					
	External Plate with Lever & Cylinder Hole	SSS	804150	▲	▲
	Internal Plate with Lever & Turnsnib Assembly	SSS	804350	▲	▲
	External Plain Plate with Lever	SSS	804550	▲	▲
	Internal Plain Plate with Lever	SSS	804650	▲	▲
	Round Rose - Full Set with 10 Lever	SSS	802150	▲	▲
		Black	802150.B	▲	▲
	Round Rose - Full Set with 34 Lever	Black	802160.B	▲	▲
	Turn Snib - Round Escutcheon	SSS	802007	▲	▲
		Black	802007.B	▲	▲
	Oval Cylinder Hole - Round Escutcheon	SSS	802008	▲	▲
		Black	802008.B	▲	▲

COMPATIBLE WITH

IMAGE	DESCRIPTION	FINISH	CODE	BARWON WIDE STILE DOORS	BARWON NARROW STILE DOORS	BARWON SLIMLINE WITH LOCK BOX
NARROW BACKSET						
Narrow Backset Mortice Locks						
	23mm Backset Primary Latch	SSS	800400	▲	▲	
		Black	800400.B	▲	▲	
	30mm Backset Primary Mortice Locks	SSS	800110	▲	▲	
	Flip-Lock Pack (Incl. Cyl. & T-snib) 22mm Lock Tongue - Single Door	SSS	801622	▲	▲	
	Flip-Lock Pack (Incl. Cyl. & T-snib) 37mm Lock Tongue - Double Door	SSS	801637	▲	▲	
	Flip-Lock Sliding Door Fab Pack (Includes Cyl. & T-Snib)	SSS	801629	▲	▲	
	Flip Lock Hook Throw Receiver Box	SSS	801004	▲	▲	
Fliplock Cylinders						
	Oval Cylinder R Cam KD (Rabbit Ear) - To Suit Flip Lock	SSS	809050	▲	▲	
	Oval Cylinder R Cam KA (Rabbit Ear) - To Suit Flip Lock	SSS	809051	▲	▲	
Narrow 23mm Backset Lock Kits						
	23mm Backset Lock Kit with Levers (Cylinder & Turnsadb)	SSS	800420	▲	▲	
	23mm Backset Lock Kit with Levers (Cylinder & Plain)	SSS	800421	▲	▲	
	23mm Backset Lock Kit with Levers (Plain & Plain)	SSS	800423	▲	▲	
Levers to suit 23mm Backset Mortice Locks						
	External Plate with Lever and Cylinder Hole	SSS	803150	▲	▲	
	Internal Plate with Lever and Turnsadb Assembly	SSS	803350	▲	▲	
	External Plain Plate with Lever	SSS	803550	▲	▲	
	Internal Plain Plate with Lever	SSS	803650	▲	▲	
LATCHES & LEVERS						
Latches						
	Tubular Latch - 60mm Backset includes Flat Striker	SSS	801000	▲		
		Black	801000.B	▲		
	Roller Bolt	SSS	801008	▲		
	Slimline Roller Bolt	SSS	801009		▲	▲
Indicator Set						
	Standard Indicator Set	—	800010	▲	▲	▲
Lever Sets						
	Entrance Leverset*	SSS	803004	▲		▲
	Passage Leverset*	SSS	803005	▲		▲
	Privacy Set (Emergency Slot Release & Turnsadb Inside)	SSS	803006	▲		▲
	Storeroom Set (Key Retracts Latch & Inside Escape)	SSS	803007	▲		▲
	Classroom Set (Key Unlocks Outside Lever & Inside Escape)	SSS	803008	▲		▲

* DDA compliant





























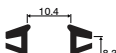





IMAGE	DESCRIPTION	FINISH	CODE	BARWON WIDE STILE DOORS
LOCKWOOD				
Standard 60mm Backset Mortice Locks				
	Mortice Primary Lock	SSS	801572	▲
	Sliding Door Mortice Primary Lock	SSS	801573	▲
Cylinders & Cams				
	Oval Cylinder 'W' Cam KD (Turnsnib) Suits 801572 & 801582	SSS	809010	▲
	Oval Cylinder 'W' Cam KA (Turnsnib) Suits 801572 & 801582	SSS	809011	▲
	Oval Cylinder 'Z' Cam KD (Locks Handles) Suits 801572 & 801582	SSS	809020	▲
	Oval Cylinder 'Z' Cam KA (Locks Handles) Suits 801572 & 801582	SSS	809021	▲
	Oval Cylinder 'X' Cam KD (Retracts Bolt) Suits 801572 & 801582	SSS	809030	▲
	Oval Cylinder 'X' Cam KA (Retracts Bolt) Suits 801572 & 801582	SSS	809031	▲
	Oval Cylinder 'Y' Cam KD (Retracts Bolt) Suits 801573	SSS	809040	▲
	Oval Cylinder 'Y' Cam KA (Retracts Bolt) Suits 801573	SSS	809041	▲
	Turnsnib Adaptor Lock Handles	SSS	801580	▲
	Turnsnib Adaptor Retract Latching Bolt	SSS	801583	▲
	Turnsnib Adaptor Retract Deadbolt	SSS	801585	▲
Levers to suit 60mm Backset Mortice Locks				
	External Plate with Lever & Cylinder Hole	SSS	801801	▲
	External Plain Plate with Lever	SSS	801805	▲
	Internal Plate with Lever & Turnsnib Assembly	SSS	801904	▲
	Internal Plate with Lever	SSS	801905	▲
	Round Rose Lever Set	SSS	801360	▲
	Round Escutcheon Oval Cylinder Hole	SSS	801366	▲
	Round Escutcheon/Indexing Turnsnib Assembly	SSS	801367	▲









IMAGE	DESCRIPTION	FINISH	UNIT	CODE	COMPATIBLE WITH		
					BARWON WIDE STILE DOORS	BARWON NARROW STILE DOORS	BARWON SLIMLINE WITH LOCK BOX
LOCKWOOD CONTINUED							
Narrow 23mm Backset Mortice Locks							
	Narrow Backset Mortice Primary Latch	SSS	—	801582	▲	▲	
Levers to suit 23mm Backset Mortice Locks							
	External Plate with Lever & Cylinder Hole	SSS	—	801481	▲	▲	
	External Plain Plate with Lever	SSS	—	801485	▲	▲	
	Internal Plain Plate with Lever & Turnsnob Assembly	SSS	—	801494	▲	▲	
	Internal Plain Plate with Lever	SSS	—	801495	▲	▲	
Lever Sets							
	Entrance Set	SSS	—	801930	▲		▲
	Passage Set	SSS	—	801931	▲		▲
RUBBERS & SEALS							
Rubbers							
	6.38mm Glazing Rubber / V102	Black	Lineal Metre	841020.B	▲	▲	▲
	8.38mm Glazing Rubber / V101A	Black	Lineal Metre	841025.B	▲	▲	▲
	10.38mm Glazing Rubber / V101C	Black	Lineal Metre	841011.B	▲	▲	▲
	12.38mm Glazing Rubber / V103A	Black	Lineal Metre	841013.B	▲	▲	▲
	6.38mm Glazing Channel Rubber	Black	Lineal Metre	840041.B	▲	▲	▲
		Grey	Lineal Metre	840041.G	▲	▲	▲
	10.38mm Glazing Channel Rubber	Black	Lineal Metre	840042.B	▲	▲	▲
		Grey	Lineal Metre	840042.G	▲	▲	▲



COMPATIBLE WITH

IMAGE	DESCRIPTION	LENGTH	FINISH	CODE	BARWON WIDE STILE DOORS	BARWON NARROW STILE DOORS	BARWON SLIMLINE WITH LOCK BOX		
RUBBERS & SEALS CONTINUED									
Door Seals									
	Whisperwing Rubber Door Seal	Lineal Metre	Black	841469.B	▲	▲	▲		
		100m Roll	Black	841469.BBR	▲	▲	▲		
		Lineal Metre	Grey	841469.G	▲	▲	▲		
		100m Roll	Grey	841469.GBR	▲	▲	▲		
	Whisper-Lon Seal - Suits 38mm Sliding Doors	Lineal Metre	Black	843705.B	▲	▲	▲		
		100m Roll	Black	843705.BBR1	▲	▲	▲		
		500m Roll	Black	843705.BBR	▲	▲	▲		
	6.9mm Door Seal	Lineal Metre	Black	843694.B	▲	▲	▲		
		100m Roll	Black	843694.BBR	▲	▲	▲		
		Lineal Metre	Grey	843694.G	▲	▲	▲		
		100m Roll	Grey	843694.GBR	▲	▲	▲		
	6.9mm Door Seal Self Adhesive	Lineal Metre	Black	843694.BSA	▲	▲	▲		
		100m Roll	Black	843694.BSABR	▲	▲	▲		
		Lineal Metre	Grey	843694.GSA	▲	▲	▲		
		100m Roll	Grey	843694.GSABR	▲	▲	▲		
	6.9mm Door Seal with 9mm Pile	Lineal Metre	Black	843699.B	▲	▲	▲		
		300m Roll	Black	843699.BBR	▲	▲	▲		
		Lineal Metre	Grey	843699.G	▲	▲	▲		
		300m Roll	Grey	843699.GBR	▲	▲	▲		
	6.9mm Door Stop Rubber (Bulb Seal)	Lineal Metre	Black	841369.B	▲	▲	▲		
		100m Roll	Black	841369.BBR	▲	▲	▲		
	10mm Hole Plug	—	Black	810130	▲	▲	▲		
			13mm Pivot Seal	Lineal Metre	Black	843011.B	▲	▲	▲
				100m Roll	Black	843011.BB1	▲	▲	▲
				600m Roll	Black	843011.BBR	▲	▲	▲
				Lineal Metre	Grey	843011.G	▲	▲	▲
				100m Roll	Grey	843011.GB1	▲	▲	▲
				600m Roll	Grey	843011.GBR	▲	▲	▲
			16mm Pivot Seal	Lineal Metre	Black	843016.B	▲	▲	▲
				500m Roll	Black	843016.BBR	▲	▲	▲
				Lineal Metre	Grey	843016.G	▲	▲	▲
				500m Roll	Grey	843016.GBR	▲	▲	▲

COMPATIBLE WITH

IMAGE	DESCRIPTION	LENGTH	FINISH	UNIT	CODE	BARWON WIDE STILE DOORS	BARWON NARROW STILE DOORS	BARWON SLIMLINE WITH LOCK BOX
RUBBERS & SEALS CONTINUED								
Door Seals Continued								
	CI-810035 Sliding Door Acoustic Insert (Suits CI-6024) - Barwon Only	—	—	3m Length	810035	▲	▲	▲
	CI-810036 Sliding Door Acoustic Insert (Suits CI-6023) - Barwon Only	—	—	3m Length	810036	▲	▲	▲
	Perimeter Door Seal - Short Single	2100 x 1000	SSS	Each	812614	▲	▲	▲
	Perimeter Door Seal - Long Single	2700 x 1000	SSS	Each	812616	▲	▲	▲
	Perimeter Door Seal - Short Double	2100 x 2000	SSS	Each	812617	▲	▲	▲
	Perimeter Door Seal - Long Double	2700 x 2000	SSS	Each	812618	▲	▲	▲
	Heavy Duty Door Base Seal	Base 920	SSS	Each	812675	▲	▲	▲
		Base 1070	SSS	Each	812620	▲	▲	▲
	Heavy Duty Base Door Seal (Facefix / Semi Rebate)	Base 920	SSS	Each	812623	▲	▲	▲
		Base 1070	SSS	Each	812624	▲	▲	▲
	Base Door Seal	Base 820	SSS	Each	812684	▲	▲	▲
		Base 920	SSS	Each	812685	▲	▲	▲
		Base 1070	SSS	Each	812686	▲	▲	▲
		Base 1220	SSS	Each	812687	▲	▲	▲
	Base Door Seal	Base 610	SSS	Each	812688	▲	▲	▲
	CI-810034 RP8 Sleeve (Suits CI-6024) - Barwon Only	—	SSS	3m Length	810034	▲	▲	▲

DOOR CLOSERS

Compact Door Closers - Series 4







	Compact Door Closer with Parallel Arm Bracket Size 2-4	—	SSS	Each	812112	▲	▲	▲
	Compact Door Closer - Hold Open Arm (to suit D4 Series Door Closer)	—	SSS	Each	812113	▲	▲	▲
	Compact Door Closer - Drop Plate	—	SSS	Each	812114	▲	▲	▲
	Compact Door Closer - Mount Plate	—	SSS	Each	812115	▲	▲	▲

Medium Door Closers - Series 5









	Medium Door Closer with Slide Arm & Hold Open Function - Size 1-3	—	SSS	Each	812317	▲	▲	▲
	Medium Door Close Adjustable By Position Size 2-4	—	SSS	Each	812316	▲	▲	▲



COMPATIBLE WITH

IMAGE	DESCRIPTION	FINISH	UNIT	CODE	BARWON WIDE STILE DOORS	BARWON NARROW STILE DOORS	BARWON SLIMLINE WITH LOCK BOX
DOOR CLOSERS CONTINUED							
Large Door Closers - Series 6							
	Large Door Closer Adjustable By Position with Parallel Arm Bracket Size 2-5	SSS	Each	812601	▲	▲	▲
	Large Door Closer Adjustable By Position with Parallel Arm Bracket (Slide Arm and Hold Open Function)	SSS	Each	812606	▲	▲	▲
	Large Door Closer Adjustable By Position with Parallel Arm Bracket Size 2-5	Black	Each	812601.B	▲	▲	▲
Extra Large Door Closers - Series 7							
	Extra Large Door Closer Adjustable By Position with Parallel Arm Bracket Size 2-6	SSS	Each	812701	▲	▲	▲
	Extra Large Door Closer Adjustable By Position with Parallel Arm Bracket (Slide Arm and Hold Open Function)	SSS	Each	812703	▲	▲	▲
Door Closer Accessories							
	Hold Open Arm Only (Suits Medium - Extra Large Door Closer)	SSS	Each	812605	▲	▲	▲
	Mount Plate Only (Suits Medium - Extra Large Door Closer)	SSS	Each	812609	▲	▲	▲
	Slide Rail w/Hold Open Function (Suits Medium - Extra Large Closers)	SSS	Each	812604	▲	▲	▲
		Black	Each	812604.B	▲	▲	▲
Transom Closers							
	Overhead Transom Closer Kit – Includes Closer, Top Arm & Base Arm	SSS	Each	812412	▲	▲	▲
	Transom Closer Hold Open 90 Degrees	SSS	Each	812413	▲	▲	▲
	Bottom Centre Pivot Set	SSS	Each	812514	▲	▲	▲
	Floor Bearing Pivot	SSS	Each	812519	▲	▲	▲
Floor Springs							
	Heavy Duty Floor Spring Kit	SSS	Each	812510	▲	▲	▲
	Top Centre Pivot Set	SSS	Each	852519	▲	▲	▲
	Bottom Strap	SSS	Each	812515	▲	▲	▲

COMPATIBLE WITH

IMAGE	DESCRIPTION	SIZE	FINISH	UNIT	CODE	BARWON WIDE STILE DOORS	BARWON NARROW STILE DOORS	BARWON SLIMLINE WITH LOCK BOX
HANDLES								
Entrance Handles								
	Chromis 61 25mm Square Section Back to Back	300 C x 325 L	SSS	Pair	815001	▲	▲	▲
		600 C x 625 L	SSS	Pair	815002	▲	▲	▲
		600 C x 625 L	Black	Pair	815002.B	▲	▲	▲
	Chromis 62 32mm Round Back to Back	32 D x 300 C	SSS	Pair	815010	▲	▲	▲
		32 D x 600 C	SSS	Pair	815011	▲	▲	▲
	Chromis 63 32mm Round Offset Back to Back	32 D x 300 C	SSS	Pair	815020	▲	▲	▲
	Chromis 64 25mm Square Offset Section Back to Back	300 C x 325 L	SSS	Pair	815030	▲	▲	▲
		600 C x 625 L	SSS	Pair	815031	▲	▲	▲
		600 C x 625 L	Black	Pair	815031.B	▲	▲	▲
	Chromis 66 32mm Round Back to Back H Pull	32 D x 450 C x 600 L	SSS	Pair	815050	▲	▲	▲
		32 D x 600 C x 1000 L	SSS	Pair	815051	▲	▲	▲
	Chromis 69 Premium Push/Pull Set	300 x 100	SSS	Pair	815080	▲		
	Chromis 69 Pull Plate Plain - Concealed Fix	300 x 65	SSS	Pair	815083	▲		
	Chromis 69 Pull Plate Plain - Visible Fix	300 x 65	SSS	Pair	815230.5	▲		
	Chromis 69 Push Plate - Visible Fix	300 x 65	SSS	Pair	815230.6	▲		
	Chromis 69 Push/Pull Plate Set - Visible Fix	300 x 65	SSS	Pair	815230.7	▲		
Flush Pull / Finger Pull								
	Flush Pull - Pair	146mm H x 40mm W	SSS	Each	816146	▲	▲	▲
	Edge Finger Pull	70H x 19 x 17D	SSS	Each	817154	▲	▲	▲



BARWON HARDWARE

IMAGE	DESCRIPTION	FINISH	UNIT	CODE	COMPATIBLE WITH		
					BARWON WIDE STILE DOORS	BARWON NARROW STILE DOORS	BARWON SLIMLINE WITH LOCK BOX
HINGES							
	Stainless Steel Interfold Hinges	SSS	Each	811020	▲	▲	▲
		Black	Each	811020.B	▲	▲	▲
		SSS	Box of 20	811020BR	▲	▲	▲
	Quick Fix Hinges	Clear Anodised	Each	811030.1	▲	▲	▲
		Black	Each	811030.B	▲	▲	▲
		White	Each	811030.W	▲	▲	▲
		Clear Anodised	Box of 20	811030.1BR	▲	▲	▲
	Aluminium Fast Fix Lift off Hinge LH	Clear Anodised	Each	811031.LH	▲	▲	▲
	Aluminium Fast Fix Lift off Hinge RH	Clear Anodised	Each	811031.RH	▲	▲	▲
	McCallum 104 Fast Fix Hinge	Mill Finish	Each	811032.0	▲	▲	▲
		Clear Anodised	Each	811032.1	▲	▲	▲
		Black	Each	811032.2B	▲	▲	▲
	LH Lift Off Butt Hinge	SSS	Each	811050	▲	▲	▲
	RH Lift Off Butt Hinge	SSS	Each	811051	▲	▲	▲
	100 x 75mm Std Butt Hinge (loose pin)	SSS	Each	811052	▲	▲	▲
	100 x 75mm Butt Hinge (fixed pin)	SSS	Each	811053	▲	▲	▲
	100 x 100mm Butt Hinge (fixed pin)	SSS	Each	811054	▲	▲	▲
	Gravity Hinge Set LH SC - Hold Open	—	Pair	800020.SC.HO	▲	▲	▲
	Gravity Hinge Set RH SC - Hold Open	—	Pair	800021.SC.HO	▲	▲	▲
	McCallum A115 Interfold Hinge	Clear Anodise	Each	811036.1	▲	▲	▲
		Black	Each	811036.2	▲	▲	▲
	McCallum A117 Interfold Hinge	Clear Anodise	Each	811038.1	▲	▲	▲
		Black	Each	811038.2	▲	▲	▲

COMPATIBLE WITH

IMAGE	DESCRIPTION	SIZE	FINISH	UNIT	CODE	BARWON WIDE STILE DOORS	BARWON NARROW STILE DOORS	BARWON SLIMLINE WITH LOCK BOX
-------	-------------	------	--------	------	------	----------------------------------	------------------------------------	--

HINGES CONTINUED

Hinge Screws

	Critech Self Drilling Hinge Screw	10g x 16mm	—	Box of 1000	855016BR	▲	▲	▲
		10g x 16mm	—	Bag of 100	855016BR1	▲	▲	▲
	Critech Hinge Screw	10g x 32mm	—	Bag of 100	855032BR1	▲	▲	▲
		10g x 32mm	—	Box of 500	855032BR5	▲	▲	▲
		8g x 45mm	—	Box of 500	855045BR	▲	▲	▲
Metal Thread CSK Z/P Steel Door Frame Hinge Screw	M5 x 10mm	—	Box of 200	855010BR	▲	▲	▲	









DOOR STOPS

	Pencil Door Stop - Wall Mounted	—	SSS	Each	813350	▲	▲	▲
		—	SSS	Box of 10	813350BR	▲	▲	▲
	Triangular Base Door Stop - Floor Mounted	—	SSS	Each	813250	▲	▲	▲
		—	SSS	Box of 8	813250BR	▲	▲	▲
	Cylinder Door Stop - Floor Mounted	—	SSS	Each	813280	▲	▲	▲
		—	SSS	Box of 15	813280BR	▲	▲	▲
	Half Moon Door Stop - Floor Mounted	—	SSS	Each	813290	▲	▲	▲
		—	Black	Each	813290.B	▲	▲	▲
		—	SSS	Box of 20	813290BR	▲	▲	▲
	Square Door Stop	—	SSS	Each	813300	▲	▲	▲

SPIGOTS

	Midrail Spigot	—	—	Each	810030	▲	▲	▲
	Barwon Spigot Pack	—	—	Each	810046	▲	▲	▲

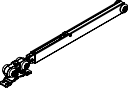
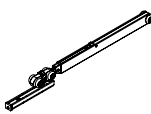

IMAGE	DESCRIPTION	SIZE	FINISH	UNIT	CODE	COMPATIBLE WITH		
						BARWON WIDE STILE DOORS	BARWON NARROW STILE DOORS	BARWON SLIMLINE WITH LOCK BOX
FLUSH & PANIC BOLTS								
	Flush Bolt Mechanism & Rod - Aluminium Doors	300mm	SSS	Each	814230	▲	▲	▲
		600mm	SSS	Each	814260	▲	▲	▲
	Flush Bolt Keeper (Screw Down)	—	—	Each	841303	▲	▲	▲
	Top Hat Ferrule	—	SSS	Each	814302	▲	▲	▲
	Visible Fix Panic Bolts	300mm	SSS	Each	818300	▲	▲	▲
		600mm	SSS	Each	818600	▲	▲	▲
	Concealed Fix Panic Bolt	300mm	SSS	Each	818301	▲	▲	▲
		600mm	SSS	Each	818601	▲	▲	▲
DOOR ROLLERS								
	Arctic Standard Roller Pack with Quick Fix Plates	—	—	Each	817020	▲	▲	▲
	Arctic Low Clearance Roller Pack	—	—	Each	817022	▲	▲	▲
	Arctic 80kg Soft Close Standard Plate, Roller Pack	—	—	Each	817024	▲	▲	▲
	Arctic 40kg Soft Close Standard Plate, Roller Pack	—	—	Each	817025	▲	▲	▲
	Arctic 80kg Soft Close Low Clearance, Roller Pack	—	—	Each	817026	▲	▲	▲
	Arctic 40kg Soft Close Low Clearance, Roller Pack	—	—	Each	817027	▲	▲	▲
	Amazon Roller - Roller and Sleeve	—	—	Each	810045	▲	▲	▲
	Atlantic Sliding Door Roller Pack	—	—	Each	817015	▲	▲	▲



Barwon Door



Diversity to adapt.

Looking to discover more?

Contact us to book your
free demonstration.

www.criterionindustries.com.au



VIC

23 Scanlon Drive
Epping, VIC, 3076
T: 03 9355 0700

sales@criterionindustries.com.au

NSW

95 Victoria Street
Smithfield, NSW, 2164
T: 02 9355 0700

294-298 Norton Street
Leichhardt, NSW 2040
T: 02 3568 2788

sales.nsw@criterionindustries.com.au

WA

58 Tacoma Circuit
Canning Vale WA 6155
T: 08 9355 0700

sales.wa@criterionindustries.com.au

QLD

22 Holt Street
Eagle Farm QLD 4009
T: 07 3193 8990

sales.qld@criterionindustries.com.au